

linear dimension(Tolerances Standard GB/T 14486-2008)

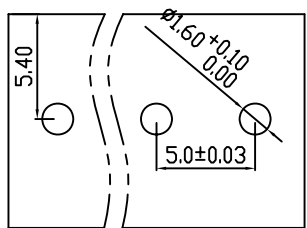

variable range	to 6	over 6	over 10	over 30	over 60	over 100	over 160	to 10	over 10	over 100
		to 10	to 30	to 60	to 100	to 160	to 100		to 100	
tolerance	±0.20	±0.30	±0.50	±0.70	±1.00	±1.30	±1.60	0.10	0.30	0.60



PCB LAYOUT

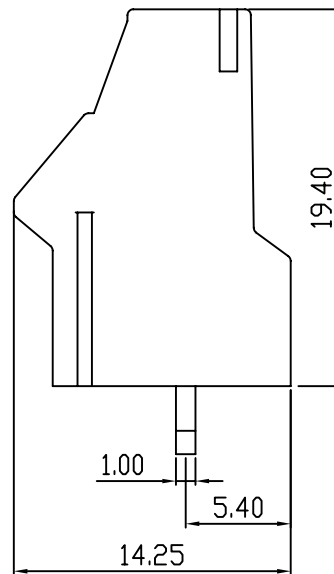
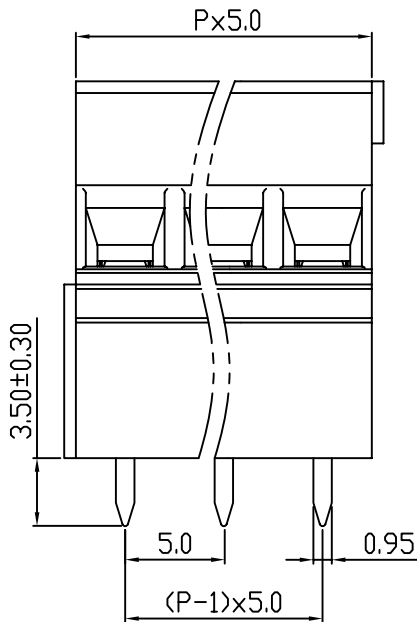
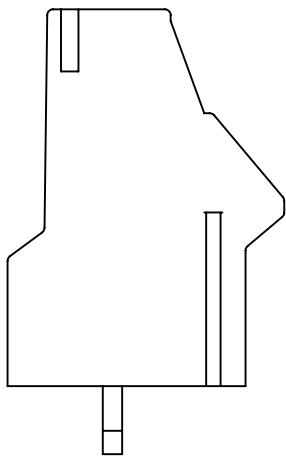
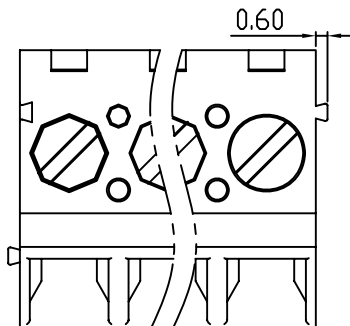

REVISION RECORD

REV.	DESCRIPTION	ECN No.	APPROVED	DATE
A	新发行		CLF	21.03.13

UL/CUL 技术参数 UL/CUL Technical Data				
等级 Use Group	B	C	D	
额定电压 Rated Voltage [V]	300	-	300	
额定电流 Rated Current [A]	20	-	10	
接线范围 Wire Range	24-12			
单/多芯线 Solid/Stranded [AWG]	24-12			
耐电压 Withstanding Voltage	1600V/1Min			
IEC 技术参数 IEC Technical Data				
过电压类别 Overvoltage Category	III	III	II	
污染等级 Contamination Class	3	2	2	
额定电压 Rated Voltage [V]	250	400	630	
额定电流 Rated Current [A]	24	24	24	
额定冲击电压 Impulse withstand voltagea [KV]	4.0	4.0	4.0	
导线截面积 Conductor cross section	2.5			
硬质/柔性导线 Solid/ flexible [mm ²]	2.5			
材料 Material				
绝缘材料 Insulation Material	PA66			
阻燃等级 Imflammability	UL94V-0			
导体材料 Contactor Material	铜合金 Copper alloy			
导体表面镀层 Contactive Coating	镀锡 Tin Plated			
一般参数 Other Data				
间距 Pitch [mm]	5.0			
极数 Poles [P]	2-24			
剥线长度 Stripping Length [mm]	6-7			
螺丝 Screw/扭矩 Torque(Max) [N.m]	M3/0.5			
工作温度 Operating temperatur [°C]	-40~+105			
引针尺寸 Pin Dimensions [mm]	3.5			
PCB板孔径 PCB Hole Diameter [mm]	1.6			

DES.	LQQ	DATE	21.03.13
CHK.	SY	DATE	21.03.13
APP.	CLF	DATE	21.03.13

单位 / UNITS	mm	尺寸 / SIZE	A4	比例 / SCALE	1:1
慈溪市科发电子有限公司 CIXI KEFA ELECTRONIC CO., LTD					

第三视角/THIRD ANGLE PROJECTION	版本 / REV	A
名称 / TITLE	KF129S-5.0	